

**MOBILE OPERATING TABLE
BETACLASSIC**





BETAClassic Economic and Powerful MAQUET – THE GOLD STANDARD



MAQUET quality standard in conjunction with cost-effectiveness: the mobile operating table BETAClassic fulfils all the user requirements of its class. It is suitable for many surgical disciplines and easy to use. The BETAClassic convinced by stability, flexibility and comfortable patient positioning.

Tried and tested features at a glance:

- Multiple section table top
- Optional longitudinal shift
- Ergonomically arranged control elements
- Pedal-operated selection calotte
- Low table height for convenient working when seated

MAQUET – The Gold Standard.

PLEASANT WORKING COMBINED WITH PATIENT SAFETY FUNCTIONS AND COMFORT

Drive and control: the hydraulic drive and the ergonomic control elements are characteristic of this sound classic model. The pedal-operated selection calotte enables precise setting of the table top positions with just a few foot operations. The OR table base in the tried and tested design offers free access and stability.



BETAClassic leaves no wishes unfulfilled: the combination of universal usage options, operating convenience and safety makes the OR table a practical all-rounder. The comprehensive OR table accessories offer the appropriate functionality for all requirements. SFC padding and the optimally covered joints ensure good positioning comfort and support the safety of the patient.

Ergonomic working:

- Table top can be set to an extremely low position, enabling ergonomic working when seated
- Optional longitudinal shift enables ideal C-arm usage
- Good access to the patient, for example, for minimally invasive surgery, thanks to the abduction joints at the leg plate mounting point

BETACLASSIC EXAMPLES OF PATIENT POSITIONING



Positioning for laparoscopic surgery, good access thanks to abduction joint



Lithotomy position with leg holder



Beach-Chair position for shoulder surgery, in reverse



Fracture treatment with extension device



Supine position for neurosurgical procedures



Supine position for procedures in the head area, low height enables ergonomic working when seated

TECHNICAL DATA ACCESSORIES

TECHNICAL DATA

Dimensions	
Length with head rest	2080 mm (81.8")
Length without head rest	1800 mm (70.8")
Width	510 mm (20")
Width across side rails	570 mm (22")
Height (without padding)	600 mm – 950 mm (23" – 37")

Weight	
Net weight	175 kg (385 lbs)
Maximum overall load	155 kg (341 lbs)

Adjustment options	
Inclination	+25° / -25°
Lateral tilt	15°
Back plate up/down	+60°/50°
Leg plate up/down	0°/95°
Longitudinal shift (optional)	290 mm (11")

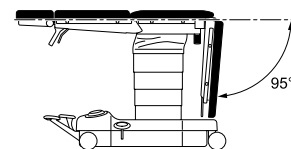
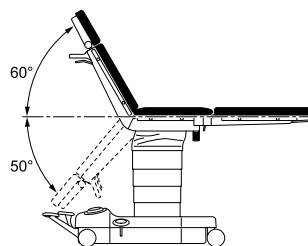
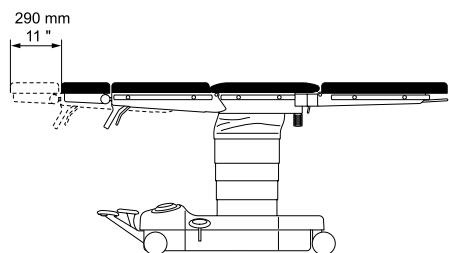
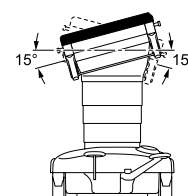
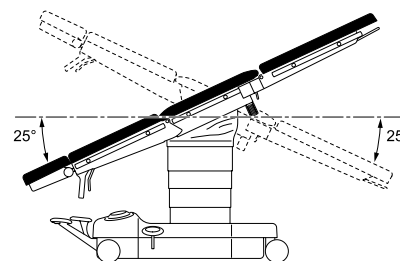
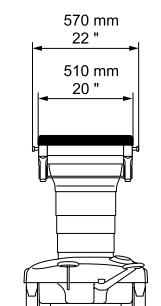
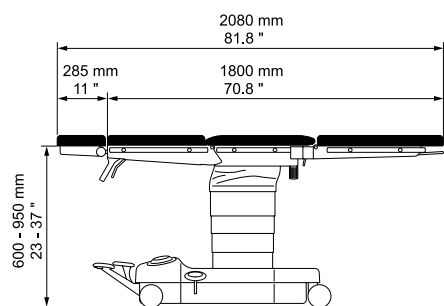

GENERAL CONSTRUCTION FEATURES

- Pedal-operated hydraulic drive for the basic functions, height, lateral tilt and inclination
- Stable base construction with large double castors for easier transportation and maneuvering
- Base cover made from fiberglass reinforced compound plastic, impact, break and disinfection-proof
- Entire table top frame and column casing made from CrNi steel

FEATURES OF THE OR TABLE TOP

- Divided in 5 sections, head rest (optional), back plate, seat plate and leg plates (optional)
- SFC padding (Special Foam Core), pad thickness 80 mm
- With guide rails for insertion of X-ray cassette (from the head end)
- Reverse positioning of the patient with the back plate for shoulder operations (optional) mounted to the foot end mounting point

VARIATIONS

- 1118.01B0 BETAClassic, mobile operating table with hydraulic adjustment and SFC padding, without head rest and leg plates
- 1118.01K0 like 1118.01B0, with longitudinal shift

OPTIONAL ACCESSORIES

- 1130.64C0 head rest, can be tilted, SFC
- 1118.50B0 pair of leg plates, can be abducted
- 1007.18B0 back plate for shoulder operations
- 1007.20A0 trolley
- 1419.01C0 extension device



For local contact:
Please visit our Website
www.maquet.com

MAQUET

GETINGE GROUP

MAQUET GmbH
Kehler Str. 31
76437 Rastatt, Germany
Phone: +49 7222 932-0
Fax: +49 7222 932-571
info.sales@maquet.de
www.maquet.com

GETINGE GROUP is a leading global provider of products and systems that contribute to quality enhancement and cost efficiency within healthcare and life sciences. We operate under the three brands of ArjoHuntleigh, GETINGE and MAQUET. ArjoHuntleigh focuses on patient mobility and wound management solutions. GETINGE provides solutions for infection control within healthcare and contamination prevention within life sciences. MAQUET specializes in solutions, therapies and products for surgical interventions, interventional cardiology and intensive care.

This document is intended to provide information to an international audience outside of the US.