

TR 900

Height Adjustable Bathtub

Hygiene Equipment
Designed for People

Operating Manual

Serial Number:



Registered at Medical Products Agency, Sweden, as a MD Class 1 product, MDD 93/42EEC.

TR reserves the right to make design changes and/or improvements without notice.



Always study this manual carefully before you attempt to operate your bathing system.

This bath system is intended for professional use only where the patient will be under supervision of trained personnel.

Operating instructions and recommended maintenance procedures are explained in the following pages.

If you have any questions regarding the operation or maintenance of your bathing system and cannot find the answer in this manual, please contact us.

The system is designed for years of trouble free operation, with proper use and maintenance.

Bathtub and shower water must be run at least every three days.

Head Office

TR Equipment AB, Sweden
Phone: +46 140 38 50 60
info@treqipment.se
www.treqipment.com

Group Subsidiaries

TR Group Inc, US, Phone: +1 (800) 752 6900
TR Equipment Ltd, UK, Phone: +44 (0) 844 335 8386
TRanspoRehaMed GmbH, Germany, Phone: +49 (0) 212 645850-0



TR EQUIPMENT

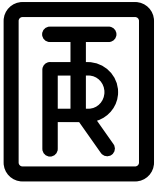

TR 900

Height Adjustable Bathtub

Hygiene Equipment
Designed for People

Table of Contents

Introduction	3
Product Description, Intended Use and Technical Specifications	4
Safety Instructions	6
Features and Controls for TR 900 , -C, -CW	8
Installation Instructions	9
User Instructions	15
Basic Operating Procedures for the TR 900 Bathtub	15
Cleaning System Operation	17
Whirlpool System Operation	19
Whirlpool System Cleaning	20
LED Color Light System	22
Autofill Controls	23
Patient Handling for the TR 900 Bathtubs	24
Preparing Tub for use	24
Ambulatory Patient Transfer	25
Patient Transfer into tub with TR 9650 Chair Lift	26
Recumbent Patient Transfer, TR 9650 Stretcher Lift	27
System Components	28
Routine Maintenance	29
Labels	30
Maintenance Record	31
Training Record	31

Head Office

TR Equipment AB, Sweden
Phone: +46 140 38 50 60
info@treqipment.se
www.treqipment.com

Group Subsidiaries

TR Group Inc, US, Phone: +1 (800) 752 6900
TR Equipment Ltd, UK, Phone: +44 (0) 844 335 8386
TRanspoRehaMed GmbH, Germany, Phone: +49 (0) 212 645850-0



TR EQUIPMENT



TR 900

Height Adjustable Bathtub

*Hygiene Equipment
Designed for People*

Introduction

Dear Customer,

Thank you for choosing one of our **quality products**. We hope you enjoy the TR 900 height adjustable bathtub.

This manual shall, in conjunction with staff training, ensure that the operator/user is always using and/or operating the TR 900 correctly.

TR requires that each user has read and understands the entire operating manual and that they can apply the instructions as specified. This applies to anyone who was not present at the in-service.

This instruction manual should generally be kept easily accessible for every user. Copying the whole of the manual is encouraged since its sole purpose is to improve the standard of training and safety.

Please order another copy from us if the instruction manual is lost or unusable or if it has become illegible over time.

If you require further information or have any questions please do not hesitate to contact TR or ask one of our qualified partners.

Please make sure you have read, understood, and applied the information on the following pages.

Head Office

TR Equipment AB, Sweden
Phone: +46 140 38 50 60
info@treqquipment.se
www.treqquipment.com

Group Subsidiaries

TR Group Inc, US, Phone: +1 (800) 752 6900
TR Equipment Ltd, UK, Phone: +44 (0) 844 335 8386
TRanspoRehaMed GmbH, Germany, Phone: +49 (0) 212 645850-0



TR EQUIPMENT

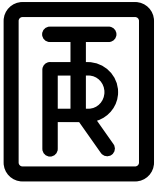

TR 900

Height Adjustable Bathtub

Hygiene Equipment
Designed for People

Product Descriptions, Intended Use and Technical Specifications

This manual includes instructions for the operation of the following equipment:

Product	Description	Version	Art no
TR 900	TR 900 Hi Lo bathtub		05192150
		UK-TMV3	05192151
		Germany	05192152
TR 900C	TR 900 Hi Lo bathtub with a built-in Cleaning system with safety valve, yellow hose and cleaning shower handle.		05192160
		UK-TMV3	05192161
		Germany	05192162
TR 900CW	TR 900 Hi Lo bathtub with a built-in Cleaning system with safety valve, yellow hose and cleaning shower handle and a Whirlpool system with air control.		05192170
		UK-TMV3	05192171
		Germany	05192173

Intended Use

Device Models:

TR 900
TR 900C
TR 900CW
TR 900A
TR 900CA
TR 900CWA

- The device “TR 900” is intended for bathing and showering of patients.
- The patient is typically a person who is unable to take care of their own personal hygiene.
- The device is not intended to be used with patients that exceeds a weight of 150 kg/330 lbs.
- The device is not intended to come in contact with for example wound or injured skin.
- The user is any adult person who is capable of reading and understanding the operating manual and is qualified to care for dependent persons/patients.
- Before using the device, the user must read and understand the operating manual.
- The device is intended to be used indoors in all types of care facilities and private homes, including hygiene areas.

Product	Description	Version	Art no
TR 900A	TR 900 Hi Lo bathtub		05192155
		Germany	05192156
TR 900CA	TR 900 Autofill bathtub with a built-in Cleaning system with safety valve, yellow hose and cleaning shower handle.		05192165
		Germany	05192166
TR 900CWA	TR 900 Autofill bathtub with a built-in Cleaning system with safety valve, yellow hose and cleaning shower handle and a Whirlpool system with air control.		05192175
		Germany	05192176

Head Office

TR Equipment AB, Sweden
Phone: +46 140 38 50 60
info@trequipment.se
www.trequipment.com

Group Subsidiaries

TR Group Inc, US, Phone: +1 (800) 752 6900
TR Equipment Ltd, UK, Phone: +44 (0) 844 335 8386
TRanspoRehaMed GmbH, Germany, Phone: +49 (0) 212 645850-0



TR EQUIPMENT

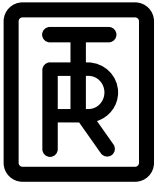

TR 900

Height Adjustable Bathtub

Hygiene Equipment
Designed for People

Technical Specifications

“TR900” is a height adjustable bathtub. The bathtub can be raised and lowered within the operating height range. The height adjustable bathtub TR 900 is designed for bathrooms in nursing homes, clinics and hospitals and consists of:

1. The tub and panel are made of glass fiber. The fibre panel covering actuator, control units and all internal sanitary installations.
2. The three-step adjustable foot support is pushed into the slots to accommodate the different lengths of patients and to avoid them from sliding and provide secure support for their feet. The foot support can be removed, for example when using a stretcher.
3. Overflow protection and pop-up drain which opens and closes the drainage system by rotating the overflow valve.
4. The thermostat mixer is designed to regulate the water temperature to the bathtub filling spout and to the handheld shower. See separate thermostat mixer operation manual for further information.
5. The shower handle with shower hose is to be used to shower the patient and to rinse equipment after cleaning.
6. One linear actuator for height adjustment within the operating height range.
7. Control buttons and thermometer are located on the panel.
8. Two legs including adjustable feet if the floor should be uneven.

Outside length	2 325 mm/92”
Outside width	830 mm/33”
Inside width (head end)	700 mm/28”
Inside width (foot end)	630 mm/25”
Inside width (tub body)	472 mm/19”
Access height	610 mm/24”
Clearance between the floor and the bottom of the tub	175 mm/7”
Max. total load	Individuals weighing no more than 150 kg/330 lbs with max
Height settings	610 - 940 mm/24” - 37”
Power supply	230 V, 50 Hz/110 V, 60 Hz
Bathtub body material	GRP
Lift stroke	330 mm
Lift speed	13 mm/s
Lifting power actuator	7000 N
Power supply	110 V/60 Hz alt. 230 V/50 Hz
Control voltage	24 V
Overall weight (empty)	265 kg/584 lbs
Bathtub faucet	See thermostat mixer operating manual

Head Office

TR Equipment AB, Sweden
Phone: +46 140 38 50 60
info@trequipment.se
www.trequipment.com

Group Subsidiaries

TR Group Inc, US, Phone: +1 (800) 752 6900
TR Equipment Ltd, UK, Phone: +44 (0) 844 335 8386
TRanspoRehaMed GmbH, Germany, Phone: +49 (0) 212 645850-0



TR EQUIPMENT

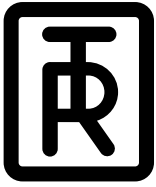

TR 900

Height Adjustable Bathtub

Hygiene Equipment
Designed for People

Safety Instructions

This HiLo bathtub may only be operated by qualified and trained staff.

Please make sure that:

- All safety and operating instructions are read and understood and that they are adhered to and applied when using the bath.
- New colleagues must be trained by qualified and experienced staff.
- The bathtub may only be installed and connected according to our assembly and installation instructions by specialists such as a certified electrical installation company. Local guidelines and regulations as well as installation rules for water and power connections must be adhered to.
- Even if you have chosen our company to install the bathtub, the cold and hot water supply and the electrical wiring is the buyer's responsibility.
- Electrical wiring must be carried out on site by a qualified electrician.
- The bathtub may only be connected to the power supply via a cord that is connected to a **GFCI (ground fault circuit interrupter)** including an easily accessible switch near the bathtub.

- Maintenance work must be carried out by specialist firms or trained staff.
- Repairs can only be carried out after consulting the supplier.
- Repairs shall only be carried out by specialist firms using original spare parts.

Every time, before the bathtub is used, please make sure that there are no visible damages/defects such as:

- Cracks in the tub body/side covers
- Damages to the main cord
- Ensure that the bathtub is lowered/raised evenly
- Make sure the tub stands stable
- There are no defects and the thermostat and option buttons are all working properly

Important: The manufacturer's warranty and liability expire automatically if modifications or repairs are carried out or if components are exchanged or opened without the manufacturer's consent.

Head Office

TR Equipment AB, Sweden
Phone: +46 140 38 50 60
info@trequipment.se
www.trequipment.com

Group Subsidiaries

TR Group Inc, US, Phone: +1 (800) 752 6900
TR Equipment Ltd, UK, Phone: +44 (0) 844 335 8386
TRanspoRehaMed GmbH, Germany, Phone: +49 (0) 212 645850-0



TR EQUIPMENT



TR 900

Height Adjustable Bathtub

Hygiene Equipment
Designed for People

Safety Instructions

If you have a question regarding the operation or maintenance of your TR 900 Bathing System and cannot find the answer in this manual, please contact us.

- When using the TR 9650 the patient must be seated comfortably on the chair and/or stretcher, with **safety belts securely attached**. Safety belts must be maintained in good condition.
- Raise Stretcher/Chair to ensure clearance of all body parts over the tub. This is to avoid the patient from being pinched between the tub rim and the Chair/Stretcher frame during transfer.
- Before raising or lowering the tub, make sure that the patients hands firmly grasp the stabilizing bar or that the patients arms are crossed over his/her body. This is to avoid pinched arms or fingers between the Stretcher/Chair frame and the tub rim.
- Wipe beneath Stretcher/Chair to prevent water dripping on the floor.
- Always physically check water temperature before and during bathing/ showering to ensure that the thermoscopic mixer is functioning. The thermostatic mixing valves are fully performance tested individually and the maximum temperature is factory preset at approximately 43 °C under ideal installation conditions at the factory.
- Make sure that all parts that come in contact with the patient are intact and without sharp edges.
- Check that hoses, tub controls, connections, mixer and thermometer are free from damage.

Warning: Always disconnect electric power before attempting any service or repair.

Warning: Never leave a patient unattended.

Head Office

TR Equipment AB, Sweden
Phone: +46 140 38 50 60
info@trequipment.se
www.trequipment.com

Group Subsidiaries

TR Group Inc, US, Phone: +1 (800) 752 6900
TR Equipment Ltd, UK, Phone: +44 (0) 844 335 8386
TRanspoRehaMed GmbH, Germany, Phone: +49 (0) 212 645850-0



TR EQUIPMENT

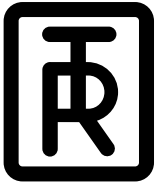

TR 900

Height Adjustable Bathtub

Hygiene Equipment
Designed for People

Features and Controls for TR 900 , -C, -CW

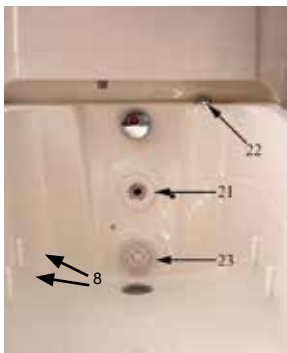
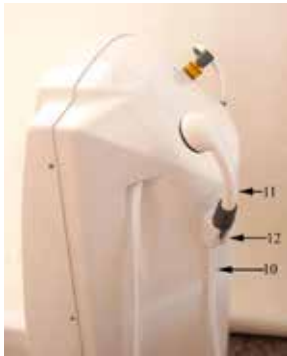
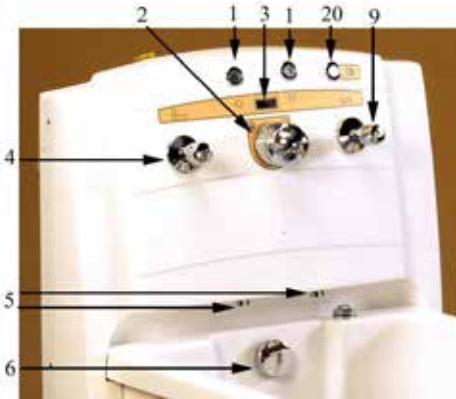

Bathtub height adjustment and filling	
1	Bathtub up/down control buttons
2	Thermostatic mixer
3	Thermometer
4	On-off valve for bathtub filling
5	Bathtub filling spout
6	Bathtub overflow drain Drain-close/open
8	Adjustable footrest, two positions

Patient shower	
2	Thermostatic mixer
3	Thermometer
9	On-off valve for patient shower
10	Patient shower hose
11	Patient shower handle
12	Handle bracket

Cleaning system (C)	
13	Shut-off safety valve
14	Spray equipment hose
15	Spray handle
16	Spray handle bracket
17	Mixing setting screw (inside the panel)
18	Detergent filling lid
19	Yellow cleaning adapter, for Whirlpool

Whirlpool system (W)	
20	Motor control on/off for whirlpool
21	Adjustable whirlpool jet
22	Air control valve
23	Whirlpool inlet safety screen



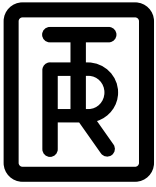

TR 900

Height Adjustable Bathtub

Hygiene Equipment
Designed for People

Installation Instructions

Bathroom layout

Recommended room size 2400 x 3000 mm, or larger.

Plumbing rough - in

Pipe, hoses and fittings, to and from bath connections including backflow preventors (check valves), shut-off valves and filters, to be supplied and installed by others and to comply with local building and plumbing regulations. To eliminate pipe debris it is essential that supply pipes are thoroughly flushed before connection of the bathtub. The bathtub drainage shall be connected to floor or wall drainage. To level the legs adjust the feet.

The TR installation set art no. 05193010 and 05193020 includes: check valves, valves with strainers and flexible hoses of 50 cm. Avoid any kinks on the hose curve when bending.

Bathtub with autofill: Set the shower flow rate by adjusting the ball-valve inside the panel located on the shower piping.

Electrical rough - in

Standard electrical requirements: 230 V, 50 Hz, 10 Amps. Permanent connection installed by others.

Note: All electrical conduit, fitting and wire to bath supplied and installed by your professional electrician in accordance with local or applicable electric code as a minimum requirement. Main switch with signal lamp, main fuse and earth circuit breaker are not included and must be supplied by others.

The SKF actuators are specified for 230/120 V AC +/- 10 %. If end user is using a power source which generates peaks outside those norms, then they should use a line filter (capacitor + choke) to regulate it.

Warning: Polarity and grounding must be correct. Improper connection may result in injury.

Weight filled	500 kg/1102 lbs
Weight empty	250 kg/551 lbs
Water volume	250 liters
Water pressure	2 - 6 bar. Inlet dynamic pressures nominally balanced to within 10 % of each other during flow
Flow rate	6 - 120 l/min
Hot water temperature	65 C. Differential of approx. 50 degrees between hot and cold water inlet temperatures.
Drainage	100 l/min

Head Office

TR Equipment AB, Sweden
Phone: +46 140 38 50 60
info@trequipment.se
www.trequipment.com

Group Subsidiaries

TR Group Inc, US, Phone: +1 (800) 752 6900
TR Equipment Ltd, UK, Phone: +44 (0) 844 335 8386
TRanspoRehaMed GmbH, Germany, Phone: +49 (0) 212 645850-0



TR EQUIPMENT

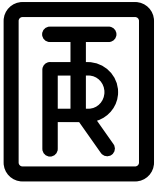

TR 900

Height Adjustable Bathtub

Hygiene Equipment
Designed for People

Installation Instructions

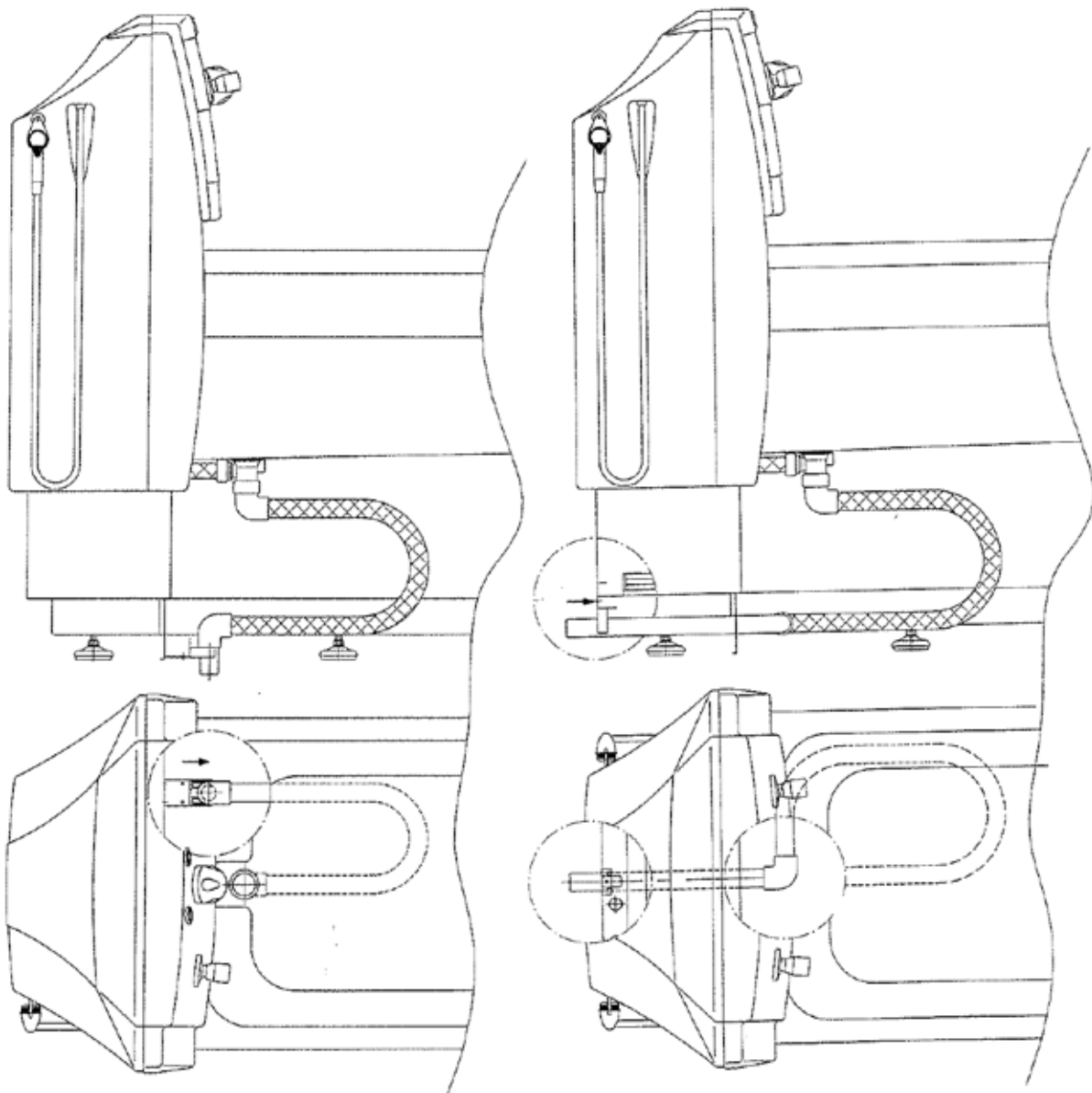

Floor Drainage

Mount the bracket for the drainage pipe to the front of the panel. Adjust by cutting the length of the pipe.

Wall Drainage

Mount the bracket for the drainage pipe to the back of the panel.

Head Office

TR Equipment AB, Sweden
Phone: +46 140 38 50 60
info@treqipment.se
www.treqipment.com

Group Subsidiaries

TR Group Inc, US, Phone: +1 (800) 752 6900
TR Equipment Ltd, UK, Phone: +44 (0) 844 335 8386
TRanspoRehaMed GmbH, Germany, Phone: +49 (0) 212 645850-0



TR EQUIPMENT



TR 900

Height Adjustable Bathtub

Hygiene Equipment
Designed for People

Installation Instructions

Installation drawing TR 900 with SKF actuators

For more information contact us:
info@treqipment.se
+46 140 38 50 60

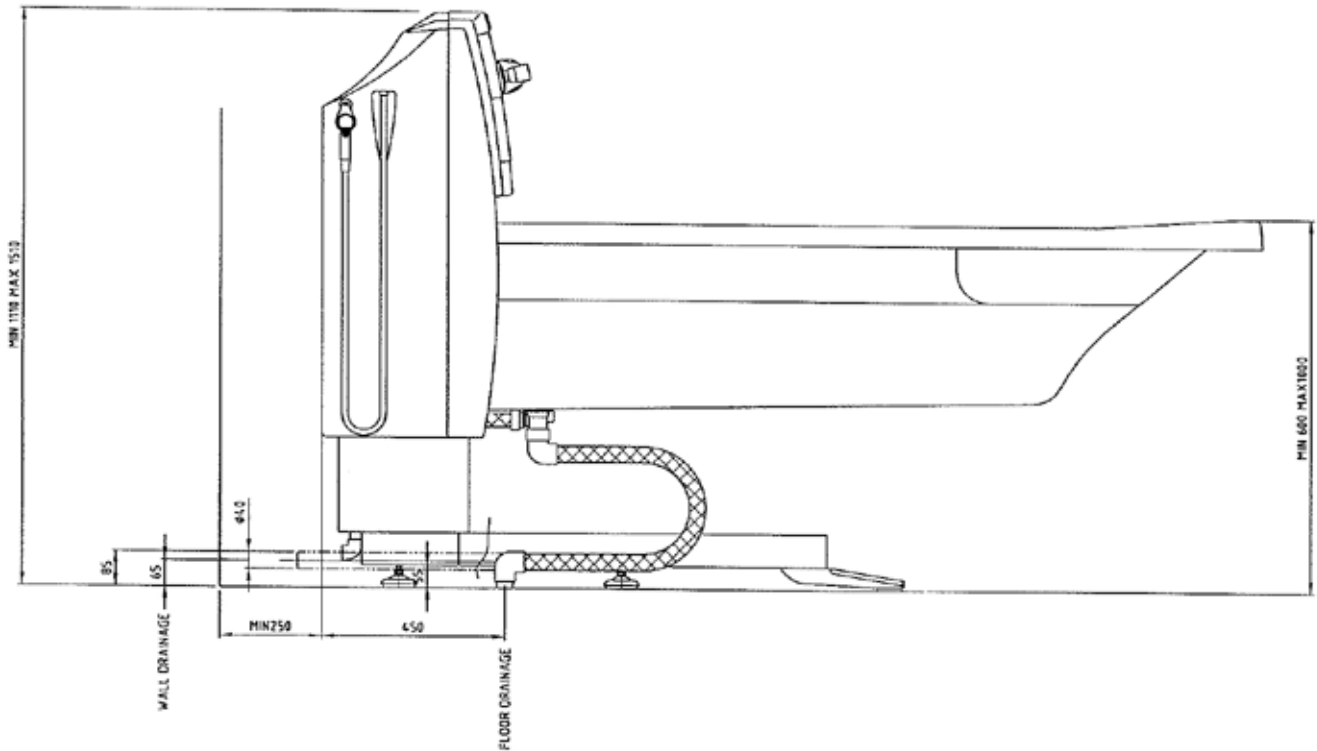

Head Office
TR Equipment AB, Sweden
Phone: +46 140 38 50 60
info@treqipment.se
www.treqipment.com

Group Subsidiaries
TR Group Inc, US, Phone: +1 (800) 752 6900
TR Equipment Ltd, UK, Phone: +44 (0) 844 335 8386
TRanspoRehaMed GmbH, Germany, Phone: +49 (0) 212 645850-0



TR EQUIPMENT

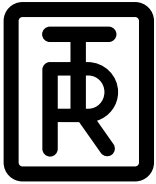

TR 900

Height Adjustable Bathtub

Hygiene Equipment
Designed for People

Installation Instructions

Installation drawing TR 900 with SKF actuators

For more information contact us:
info@treqipment.se
+46 140 38 50 60

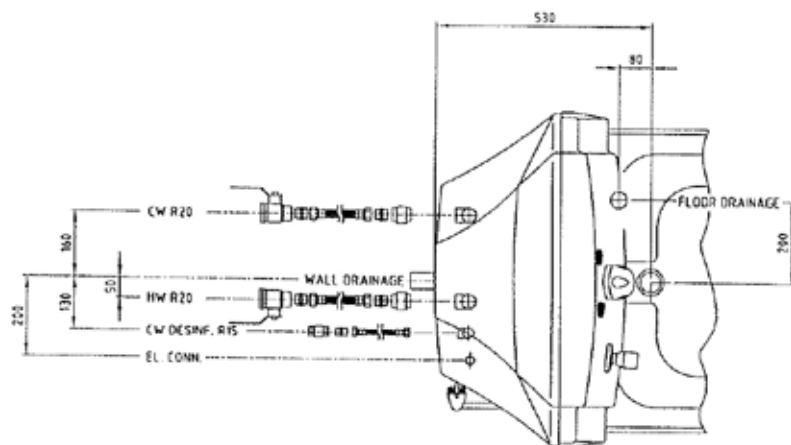
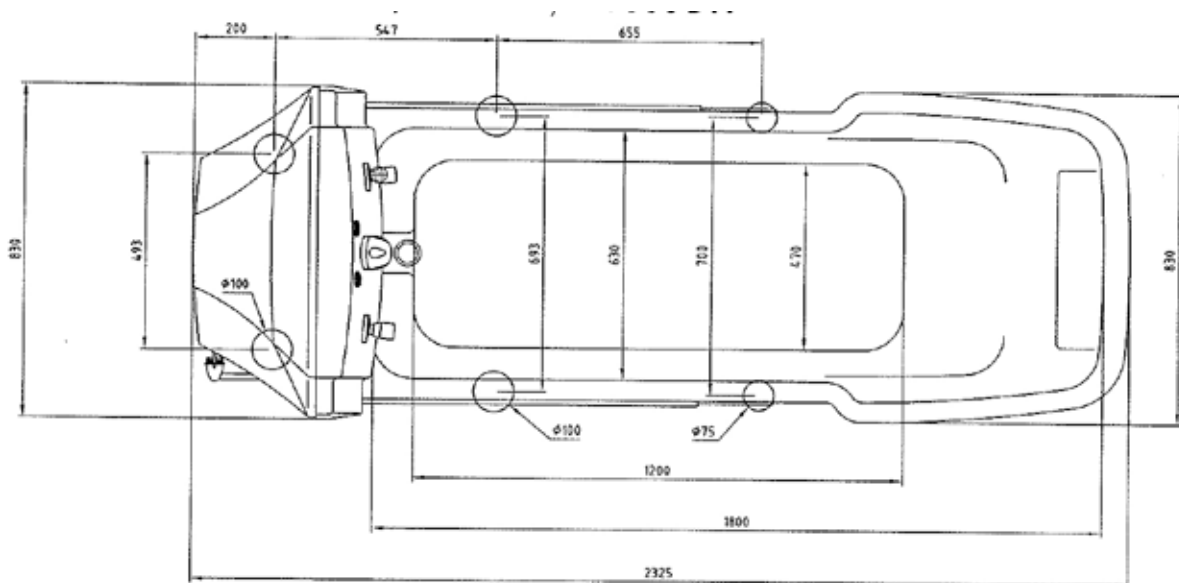

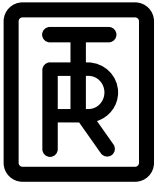

TR 900

Height Adjustable Bathtub

Hygiene Equipment
Designed for People

Installation Instructions

Installation drawing TR 900 with Linak actuators

For more information contact us:

info@treqipment.se

+46 140 38 50 60

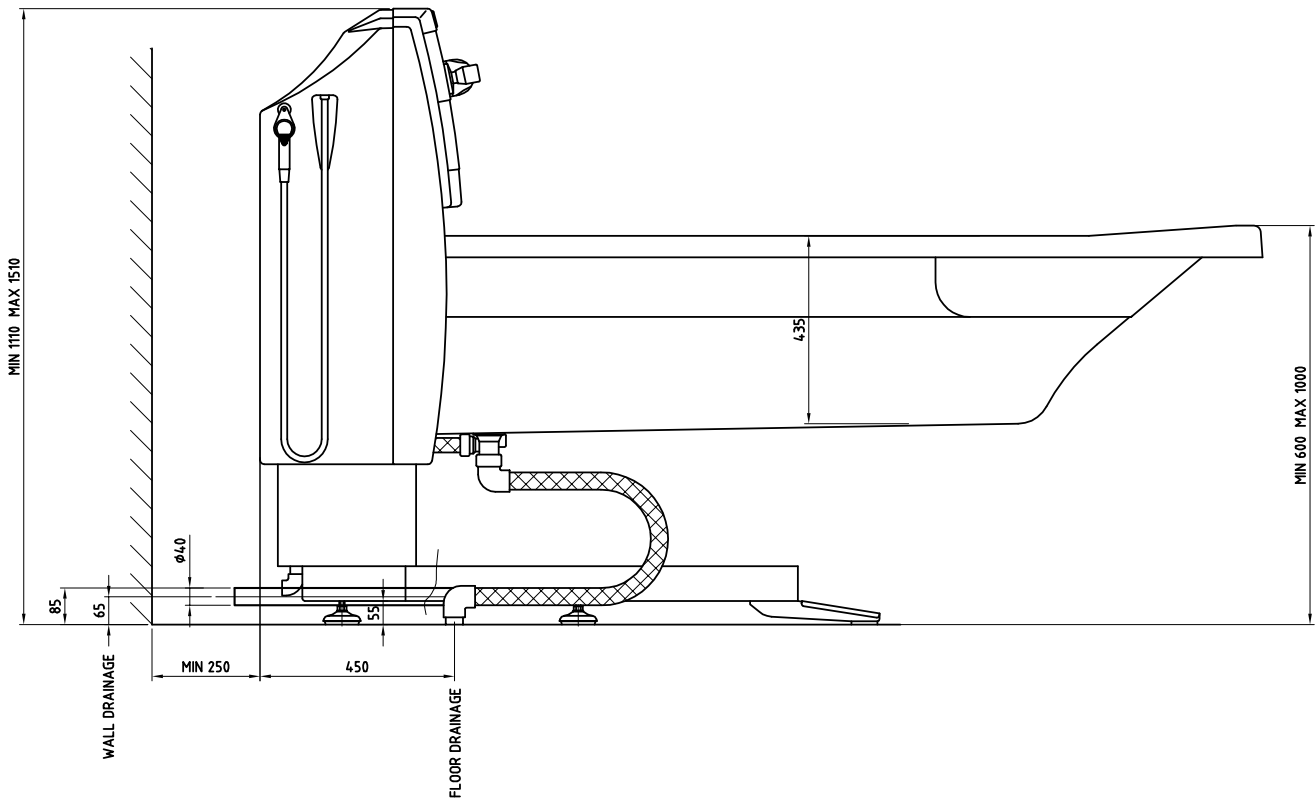
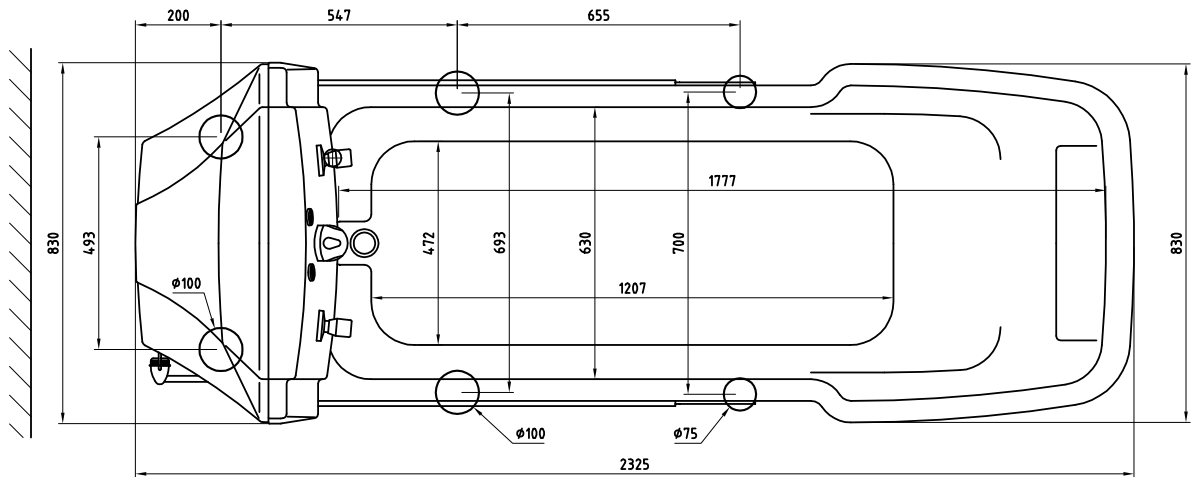

Head Office

TR Equipment AB, Sweden
Phone: +46 140 38 50 60
info@treqipment.se
www.treqipment.com

Group Subsidiaries

TR Group Inc, US, Phone: +1 (800) 752 6900
TR Equipment Ltd, UK, Phone: +44 (0) 844 335 8386
TRanspoRehaMed GmbH, Germany, Phone: +49 (0) 212 645850-0



TR EQUIPMENT

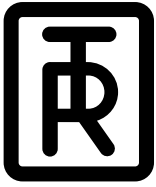

TR 900

Height Adjustable Bathtub

Hygiene Equipment
Designed for People

Installation Instructions

Installation drawing TR 900 with Linak actuators

For more information contact us:

info@treqipment.se

+46 140 38 50 60

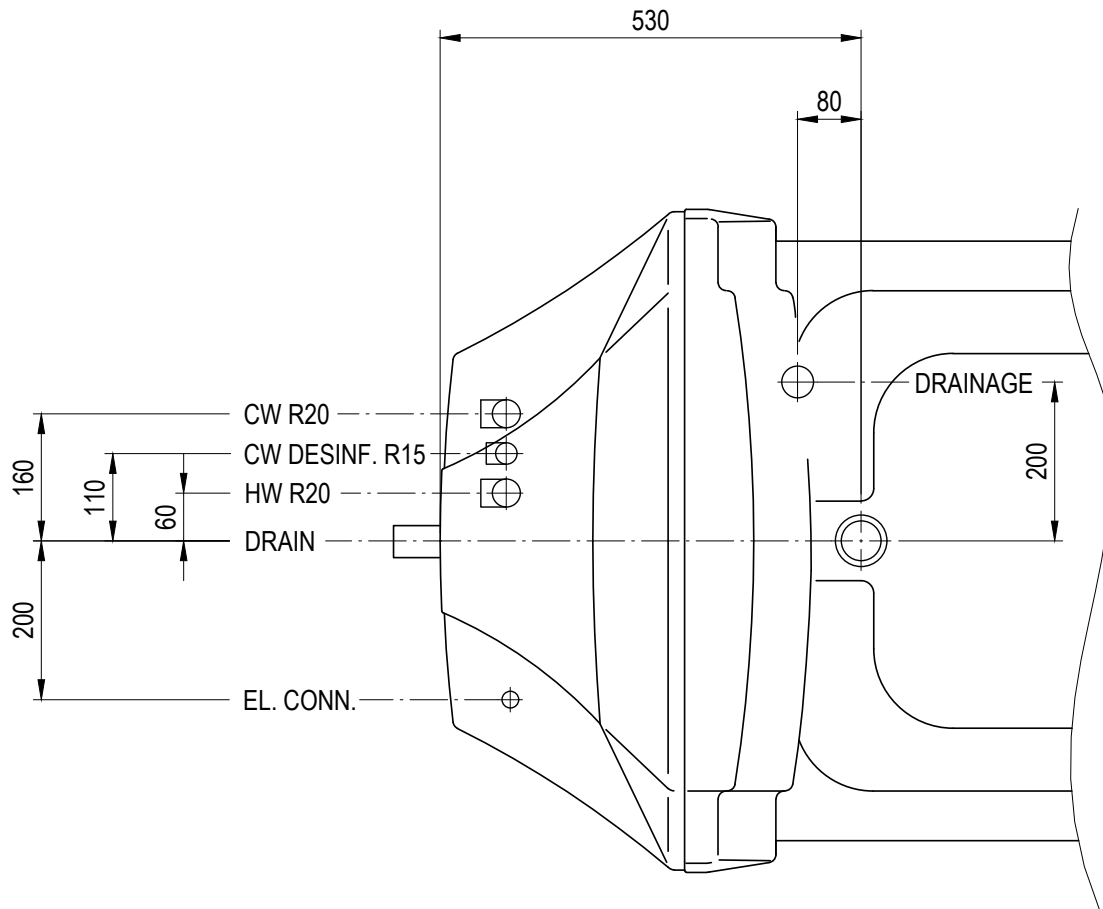

Head Office

TR Equipment AB, Sweden
Phone: +46 140 38 50 60
info@treqipment.se
www.treqipment.com

Group Subsidiaries

TR Group Inc, US, Phone: +1 (800) 752 6900
TR Equipment Ltd, UK, Phone: +44 (0) 844 335 8386
TRanspoRehaMed GmbH, Germany, Phone: +49 (0) 212 645850-0



TR EQUIPMENT



TR 900

Height Adjustable Bathtub

Hygiene Equipment
Designed for People

User Instructions

Basic Operating Procedures for the TR 900 Bathtubs

Use the following controls for filling tub and showering patients. The Whirlpool and cleaning system are described separately, see page 17-21.

Controls

The TR 900 Bathing System control panel and bathtub are made of glass fibre. It has a thermostatic mixer (2) for the bathtub filling and the patient shower. The thermostatic mixer regulates water valve temperature for the bathtub fill and the patient shower.

To calibrate the thermostatic mixer, see enclosed product manual from the manufacturer.

In addition, there are shut-off valves for the tub fill (4) and patient shower (9).

The thermometer (3) measures bathtub filling water and patient shower temperature in °C (Celsius).

The temperature probe is located close to the thermostatic mixer (2) to provide an accurate reading of water temperature as the bathtub fills.

By monitoring the thermometer you can precisely regulate water temperature with use of the thermostatic mixer (2) as the tub fills or when the patient shower (11) is used.

Height of the tub is adjusted with the tub up/down controls (1). The tub can be adjusted to any level from 600 mm (24") to 1000 mm (40") above the floor.

To lower the tub, press and hold the down button (1). To raise the tub, press and hold the up button (1).

When releasing the up or down buttons the bathtub stops in desired height position.

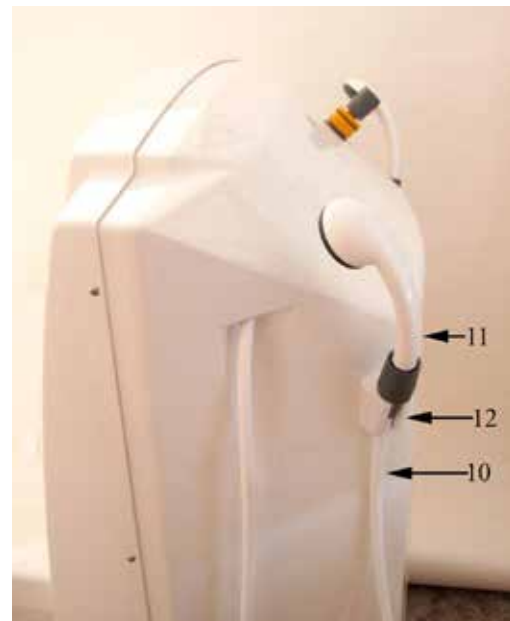
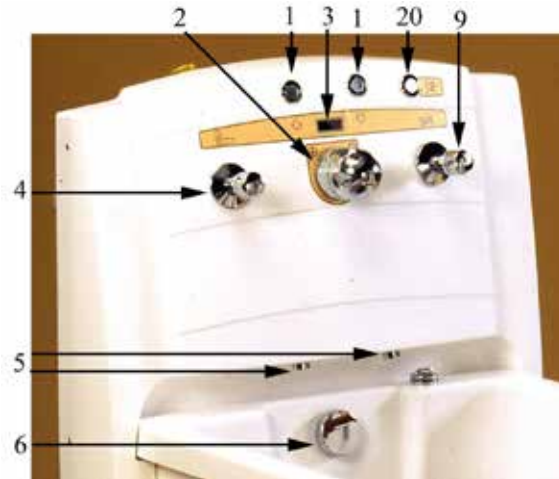

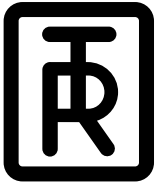

TR 900

Height Adjustable Bathtub

Hygiene Equipment
Designed for People

User Instructions

Basic Operating Procedures for the TR 900 Bathtubs

Shower System Operation

The patient shower includes a handle (11) located on the right side on the panel, the thermoscopic mixer (2) and a shut-off valve (9) on the front of the control panel.

The handle nozzle has a rubber strainer which is easy to clean, just rub your thumb over the strainer.

Using the shower:

1. Lift the shower handle (11) and hold it over tub, away from patient.
2. Turn valve (9) to "ON" position for patient shower.
3. Set the thermoscopic mixer (2) to desired temperature.
4. Physically test water temperature and adjust thermoscopic mixer (2) to suit. Adjust water flow with shut-off valve (9) located on front of control panel.
5. Shower or rinse patient with shower handle.
6. After showering, turn valve (9) to "OFF" position
7. Return the handle (11) to its bracket (12)

Note: To avoid water dripping on the floor empty the shower hose by holding the handle over the bathtub for some seconds.

The patient shower system is also useful for rinsing residue and debris from the tub when cleaning (see cleaning system description, see page 17-18).

Note: Shower handle shall not be held in the bath water while bathing.

Whirlpool

The shower hose shall be used when flushing the whirlpool system, see separate description, see page 19-21.

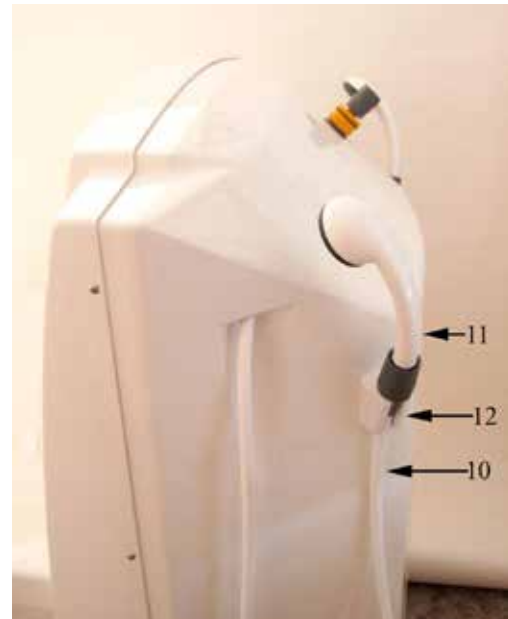
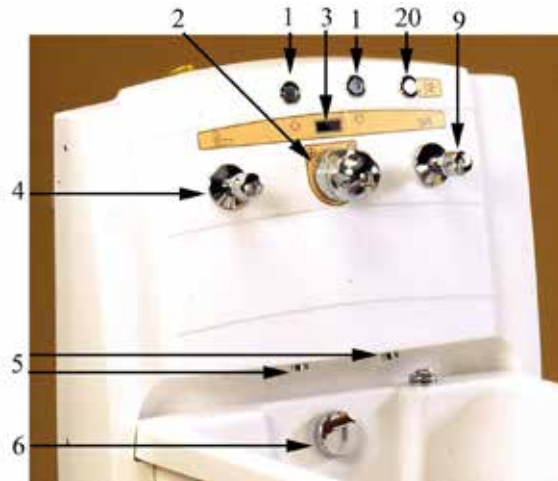

Head Office

TR Equipment AB, Sweden
Phone: +46 140 38 50 60
info@trequipment.se
www.trequipment.com

Group Subsidiaries

TR Group Inc, US, Phone: +1 (800) 752 6900
TR Equipment Ltd, UK, Phone: +44 (0) 844 335 8386
TRanspoRehaMed GmbH, Germany, Phone: +49 (0) 212 645850-0



TR EQUIPMENT

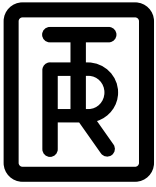

TR 900

Height Adjustable Bathtub

Hygiene Equipment
Designed for People

User Instructions

Cleaning System Operation

Important: Never to be used on patients.
Only on equipment.

The cleaning detergent is mixed with cold water to minimize inhalation.

The cleaning spray handle (15) on the yellow hose is located on the side of the control panel in a bracket (16).

Water flow is controlled by a shut-off safety valve (13) with a key, located on the left end wall of the control panel.

Detergent is automatically mixed with the water, in a pre-set concentration of appr. 2 %, controlled by a mixing setting screw (17) on the injector inside the panel. When a various calibration setting is required see next page.

Daily use of the cleaning system:

1. Remove the cleaning spray handle (15) from bracket (16). Hold the handle over the bathtub while opening the shut-off safety valve (13) with the special key.
2. Briefly spray the cleaning mixture into the tub while checking the color, smell and the foam of the mixture. Spray over all interior surfaces of the tub. Remove residue and debris with cloth or brush.
3. To clean TR Chair Lift and Stretcher Lift, position them over the tub and spray them with cleaning mixture. The Chair and Stretcher have removable pads and the Stretcher has a head pillow which can be placed in the tub for cleaning.
4. After cleaning, rinse with fresh water using the shower handle on the right side of the control panel.

Detergent filling

Open the lid (18) on top of the panel and fill with maximum 1.5 litre of concentrated detergent.

Warning: Avoid skin or eye contact with cleaning/detergent, which can be highly corrosive. If contact is made, rinse immediately with excess water. If irritation occurs, consult a doctor. Always read and follow detergent supplier directions carefully.

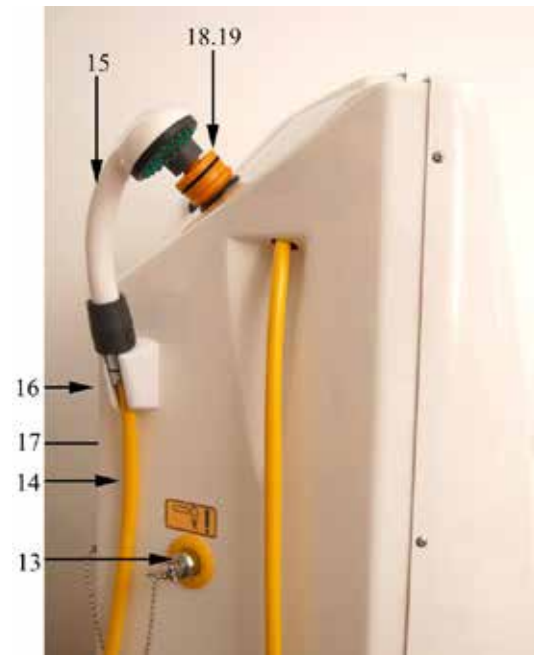

Head Office

TR Equipment AB, Sweden
Phone: +46 140 38 50 60
info@trequipment.se
www.trequipment.com

Group Subsidiaries

TR Group Inc, US, Phone: +1 (800) 752 6900
TR Equipment Ltd, UK, Phone: +44 (0) 844 335 8386
TRanspoRehaMed GmbH, Germany, Phone: +49 (0) 212 645850-0



TR EQUIPMENT

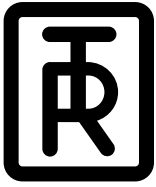

TR 900

Height Adjustable Bathtub

Hygiene Equipment
Designed for People

User Instructions

Cleaning System Operation

Calibrating the detergent mixture of the Cleaning System

Detergent is automatically mixed with the cold water, in a pre-set mixture, at the factory, of 2 %.

If an alternatively calibration is needed follow the instructions below to achieve a mixture of 2 % or what is recommended by your detergent supplier.

To calibrate the mixing setting screw (17) placed on the injector inside the panel, requires a thin screwdriver, a measuring cup with a capacity of at least 20 cl, and a bucket with at least 10 liters capacity.

- A. Remove the back panel cover.
- B. Empty the detergent bottle by loosening the hose from the injector. When empty, connect the hose to the injector again.
- C. Fill the measuring cup with 20 cl concentrated detergent, open the detergent bottle lid (18) and pour it into the bottle.
- D. Place the empty 10 liter bucket in the tub and hold the cleaning spray handle (15) with yellow hose over the bucket for filling.
- E. Open the cleaning key-grip safety valve (13) to full open position and spray into the bucket.
- F. Observe level when bucket fills, while bottle empties. Bucket should reach 10 liter mark at the same time as the bottle empties. If bucket fills first, turn the detergent mixing setting screw (17) on injector slightly counter clockwise, using the screwdriver. If bottle empties first, turn the detergent mixing setting screw (17) slightly clockwise.
- G. Repeat procedure A-F until the mixture is as required.
- H. Close cleaning key-grip safety valve (13), and return the cleaning handle (15) to the bracket (16) on side of the panel.
- I. Attach the back panel cover.

The cleaning system is now ready for use. See detergent filling on previous page.

Once the proper mixture setting is established, no further calibration is required unless a different detergent, is used.

Note: Mixture should be calibrated in accordance to your detergent supplier.





TR 900

Height Adjustable Bathtub

Hygiene Equipment
Designed for People

User Instructions

Whirlpool System Operation

TR whirlpool system allows you to regulate both water flow directions and quantity of air.

Using the whirlpool system

1. Turn the adjustable whirlpool outlet jet (21), located at the drain end of the tub, anti-clockwise to full open position.
2. Fill the bathtub making sure that the water level covers the outlet jet (21). Also, ensure that the whirlpool inlet screen (23) is in place.

Warning: Always physically check water temperature before and during bathing/showering to ensure that the thermoscopic mixer is functioning.

3. Set the adjustable whirlpool outlet jet (21) for desired flow direction: centred for perineal area; to either side for circular flow. The adjustable jet rotates in a friction housing and is easily turned to the desired position. Avoid placing the jet in a full upward position, as this could cause the water to splash.
4. With the patient in the bathtub, turn on the whirlpool unit by pushing the "ON-OFF" control button (20) on the control panel. Make sure the whirlpool inlet screen (23) is not obstructed so that full flow is maintained.
5. To make any further adjustments in water flow direction, change the adjustable whirlpool outlet jet (21).
6. Increase or decrease whirlpool stream by turning the air control (22).
7. Turn the whirlpool unit off by pushing the "ON-OFF" control button (20) on the control panel.

Note: If the whirlpool motor starts without any jet stream in the bathtub, please make sure that the adjustable whirlpool outlet jet (21), located at the drain end of the tub is fully open. If it is not, turn it counter clockwise to full open position. Make sure that the control screen (23) is in place. Do not start the pump if the screen is missing.

Warning: Disconnect electric power before attempting any service or repair.



Head Office

TR Equipment AB, Sweden
Phone: +46 140 38 50 60
info@trequipment.se
www.trequipment.com

Group Subsidiaries

TR Group Inc, US, Phone: +1 (800) 752 6900
TR Equipment Ltd, UK, Phone: +44 (0) 844 335 8386
TRanspoRehaMed GmbH, Germany, Phone: +49 (0) 212 645850-0



TR EQUIPMENT

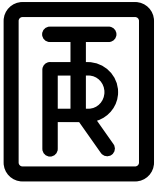

TR 900

Height Adjustable Bathtub

Hygiene Equipment
Designed for People

User Instructions

Whirlpool System Cleaning

Clean the whirlpool system

A tailor made yellow whirlpool inlet cleaning adapter (19) for the whirlpool system is delivered separately with the TR 900 CW. This is to be stored on top of the detergent filling lid (18).

1. Turn the adjustable whirlpool outlet jet (21), located at the drain end of the tub, counter clockwise to full open position.
2. Remove the whirlpool inlet safety screen (23) by turning the screen counter clockwise.
3. Fit in the yellow adapter (19) which is placed on top of the detergent filling lid (18), to the whirlpool inlet (24).
4. Remove cleaning shower handle (15) from yellow cleaning hose (14) by pressing the dots on the quick coupling.
5. Snap the hose with its coupling onto the adapter and flush cleaning through the system by turning the cleaning "key" (13) on the side of the panel.
6. Cleaning mixture will flush out through the whirlpool outlet (21) into the tub.
7. When this is done, turn cleaning system off and repeat procedure with patient shower hose (10) to flush system with fresh water.
8. Return the yellow adapter (19) onto the top of the detergent filling lid (18).

Safety and Control Instructions

- Ensure that the bottle is filled with detergent
- Never use cleaning shower handle on patients because detergent is highly corrosive. The hose is placed opposite the patient shower to prevent misuse.
- Equipment must be cleaned after each use

Warning: Avoid skin or eye contact with detergent, which is highly corrosive. If contact is made, rinse immediately with excess water. If irritation occurs, consult a doctor. Always read and follow detergent supplier instructions.

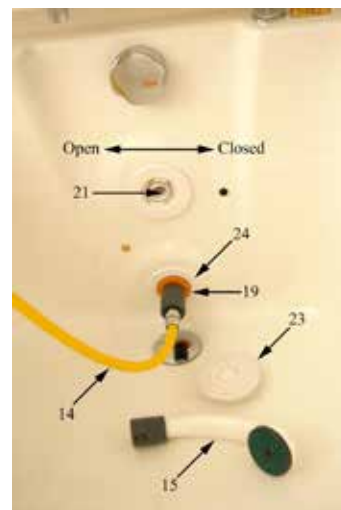
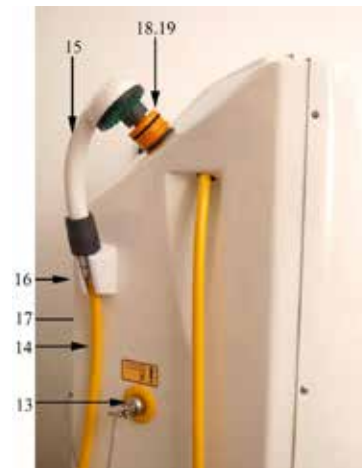

Head Office

TR Equipment AB, Sweden
Phone: +46 140 38 50 60
info@trequipment.se
www.trequipment.com

Group Subsidiaries

TR Group Inc, US, Phone: +1 (800) 752 6900
TR Equipment Ltd, UK, Phone: +44 (0) 844 335 8386
TRanspoRehaMed GmbH, Germany, Phone: +49 (0) 212 645850-0



TR EQUIPMENT

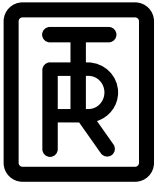

TR 900

Height Adjustable Bathtub

Hygiene Equipment
Designed for People

User Instructions

Whirlpool System Cleaning

Cleaning the adjustable whirlpool jet (21) and screen (23).

Cleaning the jet (21)

Cleaning the jet: Turn the "jet friction housing" counter clockwise 90 degrees and pull it right out. Clean the jet and the housing.

Cleaning the valve housing: remove by lifting the two hooks (inside the housing) and pull it out.

Cleaning the valve (inside): turn it counter clockwise and pull right out.

Cleaning the screen (23)

Remove the whirlpool inlet safety screen by turning it counter clockwise.

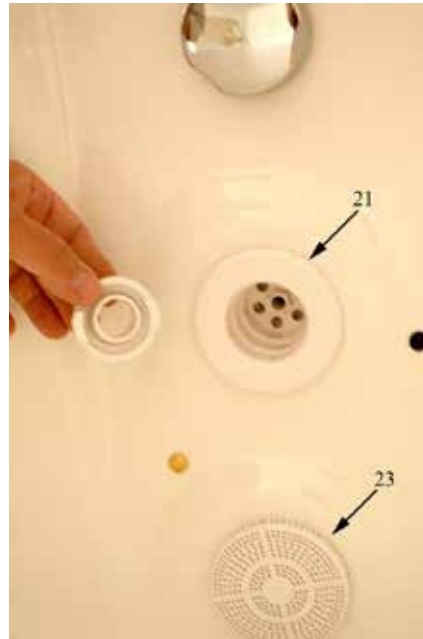

Warning: Avoid skin or eye contact with detergent, which is highly corrosive. If contact is made, rinse immediately with excess water. If irritation occurs, consult a medical doctor. Always read and follow label directions carefully.

Head Office

TR Equipment AB, Sweden
Phone: +46 140 38 50 60
info@treqipment.se
www.treqipment.com

Group Subsidiaries

TR Group Inc, US, Phone: +1 (800) 752 6900
TR Equipment Ltd, UK, Phone: +44 (0) 844 335 8386
TRanspoRehaMed GmbH, Germany, Phone: +49 (0) 212 645850-0



TR EQUIPMENT

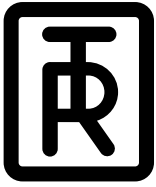

TR 900

Height Adjustable Bathtub

Hygiene Equipment
Designed for People

User Instructions

**LED Color Light System (option),
from 2016-10-10 and forward. Serial no: 1610-203483-1**

Use:

The light system touch control is located either at the head end (on the side of the tub covers) or at the foot end (on the edge of the tub, depending on bathtub model).

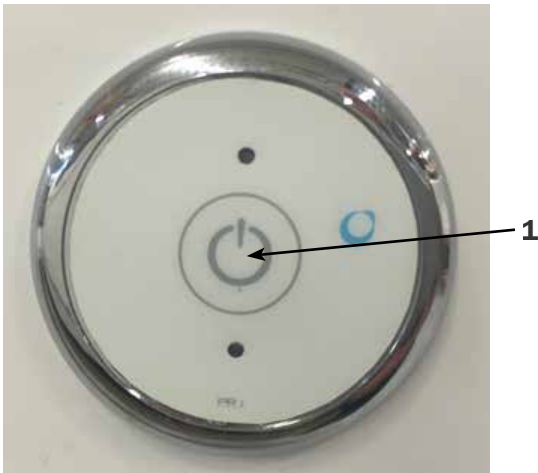

1. The light system is turned ON and OFF by pressing the power switch button (1). Diode signals that the system is in operation.
2. The light-system option allows the user to choose a particular color, which will illuminate the water via built-in floodlight until the system is turned off again. An individual color can be selected by pressing button (1) several times.
3. Press once for White color, press twice for Blue color, Third press for Red color, fourth press for Yellow color, fifth press for blue color, sixth press for RGB multi color.
4. When RGB multi color is activated the system automatically rotates between the different colors.
5. Press once more on button (1) to turn the system OFF.

Head Office

TR Equipment AB, Sweden
Phone: +46 140 38 50 60
info@trequipment.se
www.trequipment.com

Group Subsidiaries

TR Group Inc, US, Phone: +1 (800) 752 6900
TR Equipment Ltd, UK, Phone: +44 (0) 844 335 8386
TRanspoRehaMed GmbH, Germany, Phone: +49 (0) 212 645850-0



TR EQUIPMENT



TR 900

Height Adjustable Bathtub

Hygiene Equipment
Designed for People

User Instructions

Autofill Controls

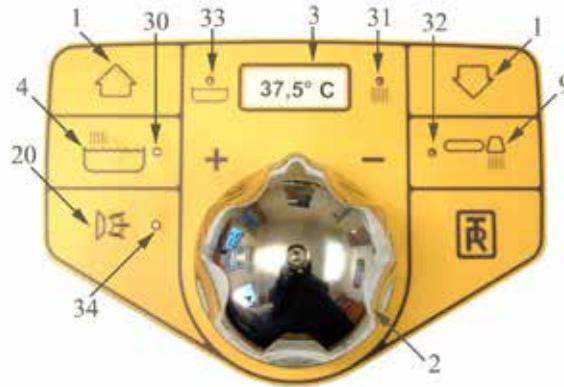

Bathtub filling

Start the automatic bathtub filling by pressing the “bathtub filling symbol” (4) to the left of the thermostat (2), the green light (30) will be lit and water starts to fill the bathtub.

The red “running water” light (31) to the right of the thermometer, indicates that the thermometer shows the filling water temperature and can be adjusted by turning the thermostat knob (2).

When the water level reaches the “waterline” inside the bathtub, (about 53 gallons, 200 litres) the bathtub filling will automatically stop and both the green (30) and the red light (31) will switch off.

The light (33) automatically indicates that the thermometer shows the still bathtub water temperature.

More water can be added into the bathtub. When pressing the “bathtub filling symbol” (4) once more, the green light (30) will flash and water will be added for approximately one minute.

This procedure can be repeated or stopped by pressing the “bathtub filling symbol” (4).

Warning: Always physically check water temperature before and during bathing/showering to ensure that the thermoscopic mixer (2) is functioning.

Showering

Remove the shower handle (11) from the panel and hold it over the bathtub away from the patient.

Press the “shower handle symbol” (9) to the right of the thermostat. The green light (32) will be lit and water starts to spray from the shower handle.

The red “running water” light (31) to the right of the thermometer indicates that the thermometer shows the running shower water temperature and can be adjusted by turning the thermostat knob.

Stop the water flow by pressing the “shower handle symbol” (9) once. Both the green (32) and the red (31) lights will switch off. The procedure can be repeated.

The shower water flow is preset when installing the bathtub. If other shower flows are required, set the water flow by adjusting the black ball valve inside the panel.

Whirlpool

To start the whirlpool system, just press the whirlpool symbol (20) and the green light (34) will be lit. To stop the whirlpool system, just press the whirlpool symbol (20) and the green light (34) will switch off.

Important: Never start the whirlpool without bathtub water covering the jet (21). Read separate whirlpool instructions, see page 19-21.

Head Office

TR Equipment AB, Sweden
Phone: +46 140 38 50 60
info@trequipment.se
www.trequipment.com

Group Subsidiaries

TR Group Inc, US, Phone: +1 (800) 752 6900
TR Equipment Ltd, UK, Phone: +44 (0) 844 335 8386
TRanspoRehaMed GmbH, Germany, Phone: +49 (0) 212 645850-0



TR EQUIPMENT

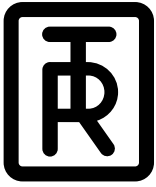

TR 900

Height Adjustable Bathtub

Hygiene Equipment
Designed for People

Patient Handling for the TR 900 Bathtubs

Preparing Tub for use

1. Close the drain plug by turning the overflow drainage knob (6).
2. Set adjustable foot rest (8) into position appropriate for the patient legs.
3. Fill tub using on-off valve (4).
Fill tub using autofill, see page 4.
4. Set and monitor fill water temperature with thermoscopic mixer (2) and thermometer (3).

Note: Footrest is not used when patients are transferred into the tub on TR's Stretcher Lift.

Warning: Always physically check water temperature before and during bathing/showering to ensure that the thermoscopic mixer (2) is functioning.

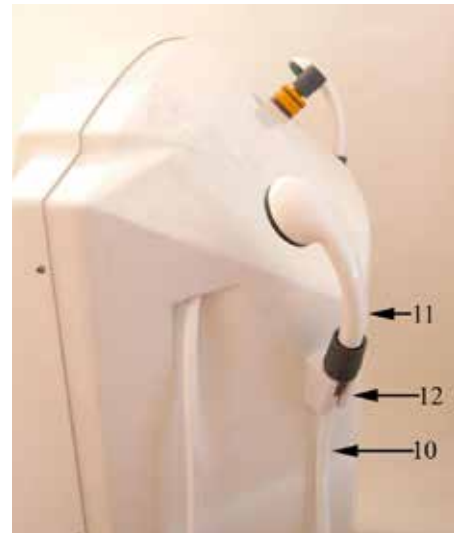
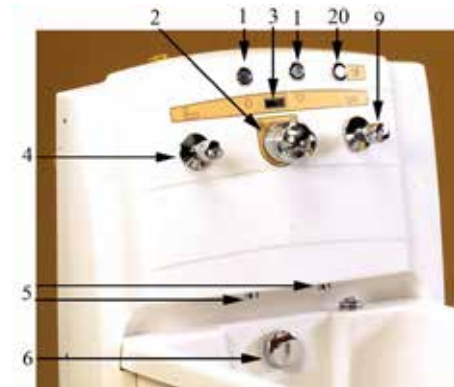

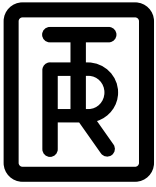

TR 900

Height Adjustable Bathtub

Hygiene Equipment
Designed for People

Patient Handling for the TR 900 Bathtubs

Ambulatory Patient Transfer

For patient comfort and safety, we recommend that ambulatory patients are transferred directly into the prefilled tub on TR's Stretcher/Chair Lift.

Refer to the Mobile Patient Combilift Operating Manual for correct procedures. See page 26 for "Patient Transfer into Tub" for recommended procedures for bathing patients on the Chair Lift and page 27 for Stretcher Lift.

Ambulatory patients can also step into the tub, in its lowest position, with assistance. When patient is comfortable, raise tub with the tub lift control (1) on the panel to a comfortable working height.

After use, lower the tub to allow the patient to exit.

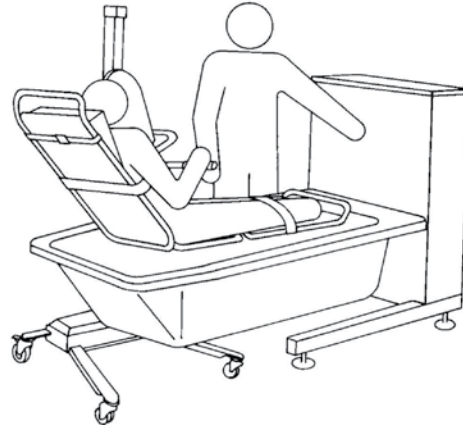

Head Office

TR Equipment AB, Sweden
Phone: +46 140 38 50 60
info@trequipment.se
www.trequipment.com

Group Subsidiaries

TR Group Inc, US, Phone: +1 (800) 752 6900
TR Equipment Ltd, UK, Phone: +44 (0) 844 335 8386
TRanspoRehaMed GmbH, Germany, Phone: +49 (0) 212 645850-0



TR EQUIPMENT

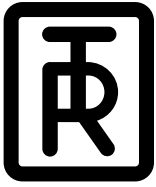

TR 900

Height Adjustable Bathtub

Hygiene Equipment
Designed for People

Patient Handling for the TR 900 Bathtubs

Patient Transfer into tub with TR 9650 Chair Lift

Sitting, safely secured patients can be transferred directly into the tub on TR Chair Lift, which is height adjustable. Refer to the TR 9650 Operation Manual for correct procedures.

Transferring patient on Chair Lift into Tub

1. Prefill the tub in its lowest position and physically test water for proper temperature. Move patient on the Chair into position over tub and lock the Chair Lift castors. The adjustable footrest in the tub can be used together with the Chair, to add patient comfort and security.

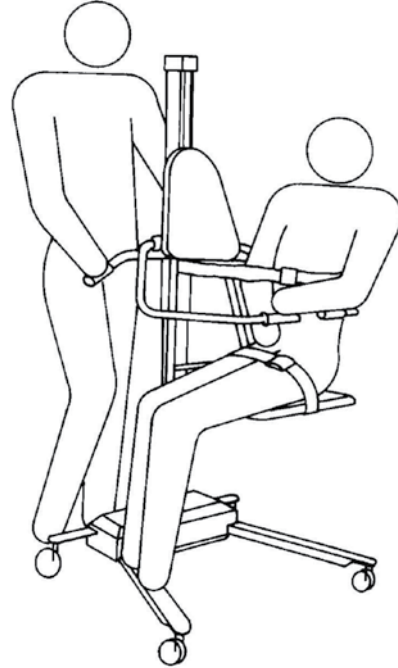

Important: Raise Chair seat to ensure clearance of all body parts over the tub rim. This is to avoid the patient from being pinched between tub rim and Chair frame during transfer.

2. Raise the tub to a comfortable working height. When the tub is at the comfortable height, lower the Chair into the tub. To add patient comfort, arm support and backrest can be rotated to outer side of tub rim.

Important: Make sure that patients arms are crossed over his/her body. This is to avoid pinching arms or fingers between Chair frame and tub rim when Chair is lowered or raised.

3. After bathing, lower the tub to raise the patient above water level to allow water to drip into the tub. You can use the patient shower system to rinse the patient in this position. The patient can then be dried or wrapped in a bath towel, and be transferred away from the bathtub.

Note: Wipe beneath Chair to prevent water dripping on the floor.

Important: Safety belts must be securely fastened around patient at all times. For further details, refer to the TR 9650 Operating Manual.

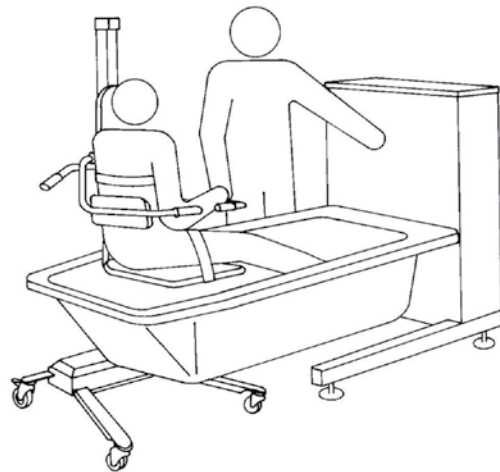

Head Office

TR Equipment AB, Sweden
Phone: +46 140 38 50 60
info@trequipment.se
www.trequipment.com

Group Subsidiaries

TR Group Inc, US, Phone: +1 (800) 752 6900
TR Equipment Ltd, UK, Phone: +44 (0) 844 335 8386
TRanspoRehaMed GmbH, Germany, Phone: +49 (0) 212 645850-0



TR EQUIPMENT



TR 900

Height Adjustable Bathtub

Hygiene Equipment
Designed for People

Patient Handling for the TR 900 Bathtubs

Recumbent Patient Transfer, TR 9650 Stretcher Lift

Recumbent patients can be transferred directly and safely secured into the tub, on TR Stretcher Lift, which is height adjustable. Refer to the TR 9650 Operating Manual for correct procedure.

Transferring patient on Stretcher Lift into Tub

1. Prefill the tub in its lowest position and physically test water for proper temperature. Move patient on the Stretcher Lift over tub and lock the Lift castors.
2. Raise the tub to a comfortable working height. When the tub is at the comfortable height, you can lower the Stretcher into the tub, using the Lift.

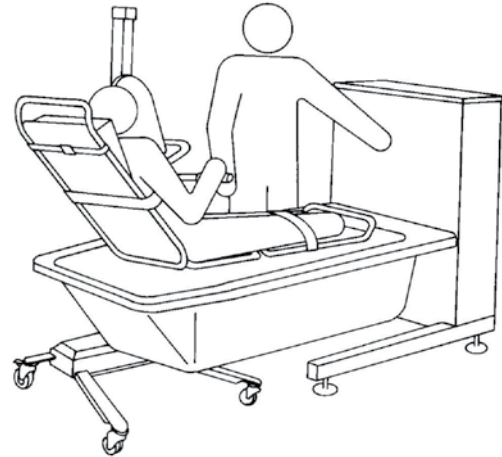

Important: Before raising or lowering the tub, make sure that the patients hands firmly grasp the stabilizing bar on the stretcher or that the patients arms are crossed over his/her body. This to prevent pinching arms or fingers between the stretcher frame and tub rim when the stretcher is lowered or raised.

3. After bathing, lower the tub to raise the patient above the water level, to allow water to drip into the tub. You can use the patient shower system to rinse the patient in this position. The patient can then be dried or wrapped in a bath towel, and be transferred from away for the bathtub.

Note: Wipe beneath stretcher to prevent water dripping on the floor.

Important: Safety belts must be securely fastened around patient at all times. For further details, refer to the TR 9650 Operating Manual.

Head Office

TR Equipment AB, Sweden
Phone: +46 140 38 50 60
info@trequipment.se
www.trequipment.com

Group Subsidiaries

TR Group Inc, US, Phone: +1 (800) 752 6900
TR Equipment Ltd, UK, Phone: +44 (0) 844 335 8386
TRanspoRehaMed GmbH, Germany, Phone: +49 (0) 212 645850-0



TR EQUIPMENT

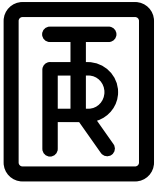

TR 900

Height Adjustable Bathtub

*Hygiene Equipment
Designed for People*

System Components

Actuators

Note: Only company engineers and/or trained staff are authorized to carry out any work on the drive system (actuators). Do not attempt work on the actuators without consulting TR Equipment as this will void the warranty!

Thermostatic Mixer

See separate operating manual, TR refers to the separate operating manual for the thermostatic mixer that was delivered together with the bath.

For Routine Maintenance see page 29 in this operating manual and also the supplier's manual on the thermostatic mixer.

Head Office

TR Equipment AB, Sweden
Phone: +46 140 38 50 60
info@treqipment.se
www.treqipment.com

Group Subsidiaries

TR Group Inc, US, Phone: +1 (800) 752 6900
TR Equipment Ltd, UK, Phone: +44 (0) 844 335 8386
TRanspoRehaMed GmbH, Germany, Phone: +49 (0) 212 645850-0



TR EQUIPMENT

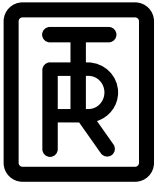

TR 900

Height Adjustable Bathtub

Hygiene Equipment
Designed for People

Routine Maintenance (Also see operating manual for thermostat mixer)

Before each time the bathtub is used:

- Visual inspection - make sure that all electrical cords are in good condition and hoses do not leak
- Make sure it stands securely on the floor
- Check the temperature setting by hand or with a bath thermometer

Daily Maintenance

- Clean the tub after every use.
- Check the cleaning supply at least daily, depending on the frequency of use.
- Avoid abrasive cleaners which may scratch the gel coat finish of the fiberglass bathtub and the panel.
- When the tub is not in use, lower it to its lowest position and make sure all valves are closed.
- Clean the strainers on the patient- and cleaning shower handles by rubbing it with your thumb.
- Visually inspect the tub interior to make sure there are no knick or cracks which may scratch the patient

Monthly: (on-site engineer or trained staff)

- Make sure the connecting hot/cold water hoses are fitted correctly and do not leak
- Check all screws and bolts
- Check the power connection cord for damages (current & potential equalization)
- Exercise the thermostatic mixing valve to ensure that the delivery of warm water is at a stable and safe temperature. This is described in the enclosed manual from the mixer manufacturer under the headline Commissioning.

Annually:

Maintenance and inspection by the manufacturer or QUALIFIED STAFF authorized by the manufacturer

- Moveable components have to be maintained and inspected regularly because they are classified as wear parts! (e.g. motor, fittings, hoses, connections, pipe interrupters. Thermostatic mixing valve.)
- Inspection of electrical installation and equipment according to local requirements should be carried out annually.
- Clean warts valve/s.

Every 5 years:

- Exchanging/replacing all connecting hot/cold water hoses.
- Replace the mixer cartridge and check valves.

Important! In healthcare applications such as hospitals, residential care homes, etc. and in any other applications where the user is similarly at risk, irrespective of supply and usage conditions or the evidence of in-service tests. TR Equipment recommends the critical components replaced at intervals of no more than 5 years.

After appr. 12 years:

- TR recommend that the actuator is replaced

Maintenance and/or repairs may only be carried out by the MANUFACTURER or qualified staff authorized by the manufacturer. Otherwise the guarantee expires immediately.

Note: Iodine, bromine, and methylene blue can discolor the fiberglass.

The recommended frequency of these maintenance procedures will depend on the hardness of your water supply and how often the equipment is used. It is good practice to establish these routine procedures on a weekly basis and then adjust the frequency as your conditions indicate.

Warning: The equipment must not be used in any way that varies from the safety precautions and operating procedures detailed in this manual. The equipment must not be operated by anyone until the user has read and understands the operating manual.

Head Office

TR Equipment AB, Sweden
Phone: +46 140 38 50 60
info@trequipment.se
www.trequipment.com

Group Subsidiaries

TR Group Inc, US, Phone: +1 (800) 752 6900
TR Equipment Ltd, UK, Phone: +44 (0) 844 335 8386
TRanspoRehaMed GmbH, Germany, Phone: +49 (0) 212 645850-0



TR EQUIPMENT

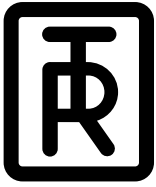









TR 900

Height Adjustable Bathtub

Hygiene Equipment
Designed for People

Labels on the TR 900

1.		Maximum working load	7.		Filling disinfectant. Maximum 0,4 gallon
2.		Mandatory to read the operating manual before use	8.		Whirlpool
3.		Specifies the maximum pressure for cold water	9.		Air mixture whirlpool
4.		Specifies the maximum pressure and temperature for the hot water			
5.		Specifies the maximum pressure of the separate cold water for disinfection system			
6.		Showerhead for Disinfection			





TR 900

Height Adjustable Bathtub

*Hygiene Equipment
Designed for People*

Maintenance Record

Date	Description	Signed by

Training Record

Date	Description	Signed by

